

**IMPORTANT! READ CAREFULLY AND KEEP THIS USER'S
MANUAL IN A SAFE PLACE FOR FUTURE REFERENCE!**

**INSTRUCTION MANUAL FOR
BABY STROLLER
"CITY"**



This stroller **chipolino** has been manufactured in accordance with the Product Safety Directive 2001/95/EU of the European Parliament and The Council and with European standard EN 1888-1 "Child care articles. Wheeled child conveyances. Part 1: Baby strollers and carry cot", and the regulations of national law, including Consumer Protection Law.

CAUTION! WARNINGS!

- ❖ **CAUTION! NEVER LEAVE YOUR CHILD UNATTENDED!**
- ❖ **CAUTION! ALWAYS USE THE RESTRAINT SYSTEM (SAFETY BELTS)!**
- ❖ **CAUTION! MAKE SURE THAT ALL LOCKING MECHANISMS ARE ENGAGED BEFORE USE.**
- ❖ **CAUTION! BEFORE EACH USE, CHECK THE STABILITY OF FIXING OF SEPARATE PARTS!**
- ❖ **CAUTION! MAKE SURE YOUR CHILD IS AT SAFE DISTANCE AWAY FROM THE STROLLER DURING ADJUSTMENTS, FOLDING OR UNFOLDING OF THE STROLLER.**
- ❖ **CAUTION! DO NOT ALLOW YOUR CHILDREN TO PLAY WITH THE STROLLER!**
- ❖ **CAUTION! THIS PRODUCT IS NOT SUITABLE FOR RUNNING OR SKATING!**
- ❖ **FOR NEWBORN BABY USE THE MOST LYING POSITION OF THE BACKREST OF THE SEAT! ALWAYS ATTACH THE CANOPY TO THE BACKREST TO PREVENT THE BABY TO FALL AND INJURE!**
- ❖ **USE THE SITTING POSITION OF THE SEAT UNIT ONLY AFTER CHILD IS LEAST 6 MONTHS OLD! SITING POSITION OF SEAT IS NOT SUITABLE FOR BABIES, WHO ARE AGED LESS THAN 6 MONTHS!**
- ❖ **DO NOT LIFT THE STROLLER BY THE FRONT BAR, BECAUSE THIS CAN LEAD TO SERIOUS INJURIES!**
- ❖ **KEEP AWAY FROM FIRE!**
- ❖ Use the stroller for a child weighing not more than 15 kg.
- ❖ Initial assembly, folding and unfolding to be done only by adult!
- ❖ Always engage the brakes when the stroller has stopped and is not moving, especially when you place or take out your child from it!
- ❖ Make sure the safety belts are fastened and fit well to the child before usage.
- ❖ Do not place an additional mattress in stroller.
- ❖ The maximum load for the storage basket is 2 kg.
- ❖ Do not overload the stroller! Always balance your stroller in a way to keep it stable and prevent the risk of tip-over!
- ❖ Stroller is intended for use for one child at a time!
- ❖ Do not use any spare parts or other components, which are not approved by the producer! The producer does not take any responsibility for the safety of the child when you have not used the proper and original spare parts, approved and provided by him!
- ❖ Do not apply any changes or modifications to the stroller's construction! Contact the dealer or an authorized repair service for advice and/or repair instead!
- ❖ Discontinue the usage, if you find worn out or loose joints, damaged or missing parts! There is a risk of injury of the child!
- ❖ Do not allow children younger than 3 years near the stroller during the assembly or disassembly, in order to prevent the risk of injury or swallowing of small parts!
- ❖ Strings can cause strangulation! Do not place additional strings to the product to avoid injuries!
- ❖ Never use the stroller on stairs or escalators! Use extra care when going up or down a pavement or step!
- ❖ The packaging of the product must be kept out of the reach of children to avoid the risk of strangulation!

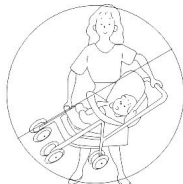

MAIN FEATURES OF PRODUCT

- ❖ Stroller is suitable for newborn babies and children aged up to 36 months or weighing up to 15 kg.
- ❖ 5-point safety harness system;
- ❖ Adjustable backrest;
- ❖ Adjustable canopy;
- ❖ Adjustable leg rest;
- ❖ Carry handle.

MAIN PARTS

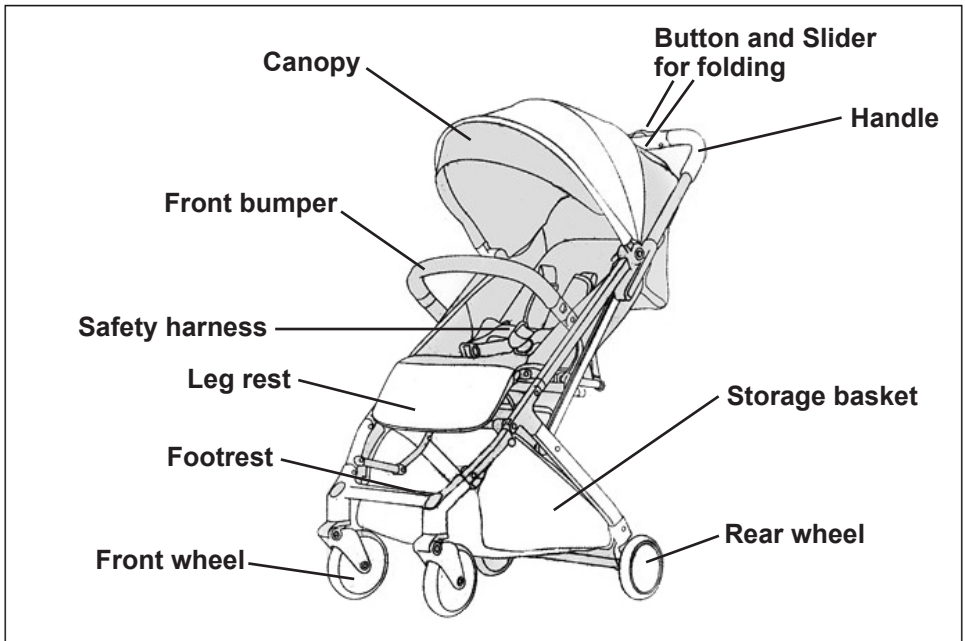

ASSEMBLY INSTRUCTIONS AND FUNCTIONS

This stroller is supplied partially assembled.
In order to complete the assembly, you do not need any tools.

- CAUTION!** Follow exactly the instructions given and check the pictures.
CAUTION! After each operation, make sure that you have followed the instructions correctly and the fixing is stable!
CAUTION! In most cases after the completion of an operation you will hear a clicking sound.

The assembly, disassembly and functions are numbered from 1 to 11.
Use the operations descriptions given in this manual and their matching picture.

1 – OPEN OF THE STROLLER

1-1 – Release the fixing and grab the handle.

1-2 and 1-3 – Pull the handle upwards until stroller opens and you hear a click sound.

2 – ASSEMBLY AND REMOVAL OF THE FRONT WHEELS

Place the front wheel to the slot at front part of the frame and press until you hear a click sound.

To remove the front wheels, press each of the releasing buttons and remove the wheels from the frame.

Note: Front wheels can only swivel.

3 – ASSEMBLY AND REMOVAL OF THE REAR WHEELS

Place the rear wheel to the slot at rear part of the frame and press until you hear a click sound.

To remove the rear wheels, press each of the releasing buttons and remove the wheels from the frame.

4 – PARKING DEVICES

IMPORTANT! Always apply the parking devices while stroller is not in motion to avoid sudden sliding and injuries!

5 – ATTACHMENT AND REMOVAL OF FRONT BUMPER

5-1 and 5-2 – Place the front bumper to the frame slots and press until you hear a click sound and it fixes.

5-3 – To remove the front bumper, press the buttons at outside and pull the bumper from the frame.

6 – UNFOLDING OF CANOPY

6-1 – Unfolding the canopy;

6-2 – Folding the canopy.

ATTENTION! Always attach the canopy to the seat to avoid falling of the child.

7 – LEG REST

Press simultaneously buttons under the leg rest and push down the leg rest. To upright the leg rest, pull upwards the leg rest until you hear a click sound!

8 – BACKREST ADJUSTMENT

Press the button at the adjusting mechanism and set it upwards/downwards to reach the required position.

CAUTION! BABIES AGED LESS THAN 6 MONTHS MUST BE PLACED IN STROLLER ONLY WHEN THE BACKREST IS IN MOST LYING POSITION!

9 – RESTRAINT SYSTEM (SAFETY HARNESS)

To fasten the belt follow the steps shown in figures 9-1, 9-2 and 9-3.

9-4 – Adjust the length of the belts via buckles as figure shows.

To unfasten the belt, press the button at central buckle and split the belts.

CAUTION! Adjust the belts so that they fit well the child and are not twisted.

CAUTION! Periodically check to ensure that the seat belt is securely attached to the stroller frame as well as securely fastened. The belts should not be worn or torn, and plastic buckles and fasteners must be sturdy, free of damage and secure.

CAUTION! When you use the seat for newborn baby, before placing the baby in the stroller you have to split the shoulder belts and waist belt from the buckle and to stow them to the stroller sides and cover them with thin mat.

10 – FOLDING THE STROLLER

CAUTION! Before folding the stroller, always activate the parking device and empty the storage basket.

10-1 – Press simultaneously the slider (1) and button (2);

10-2 – Press the handle down and forwards until stroller fully folds;

10-3 – Fixing will lock automatically.

11 – CARRY HANDLE

11-1 – Stroller has support that keeps it in upright position.

11-2 – Stroller is equipped with handle to move it easily. Pull the handle and move the folded stroller.

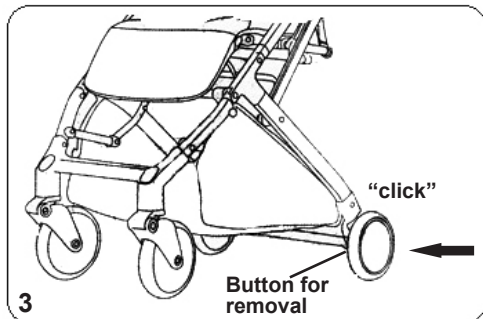
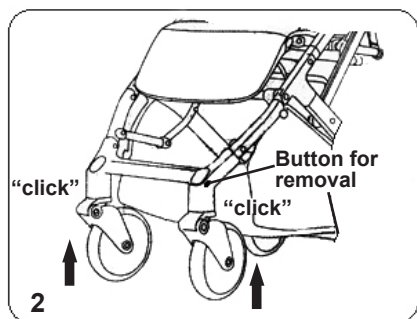
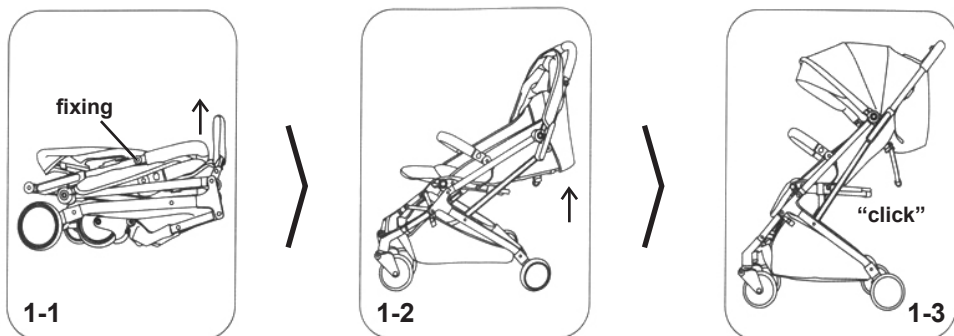

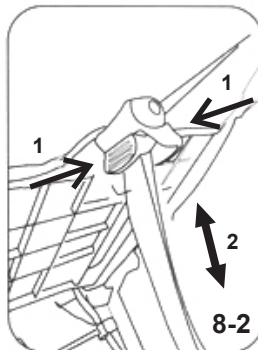
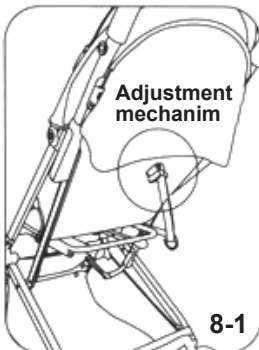
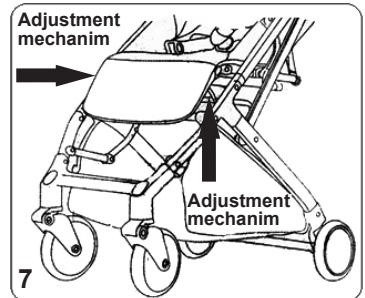
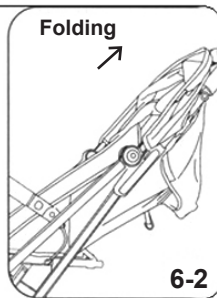
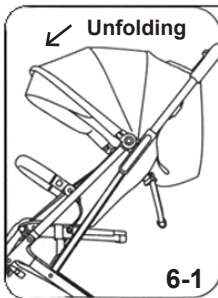
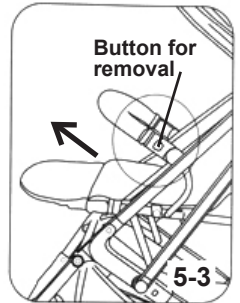
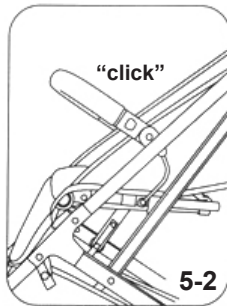
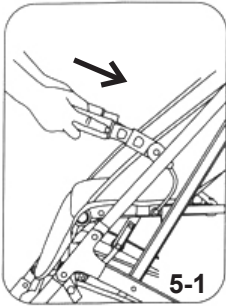
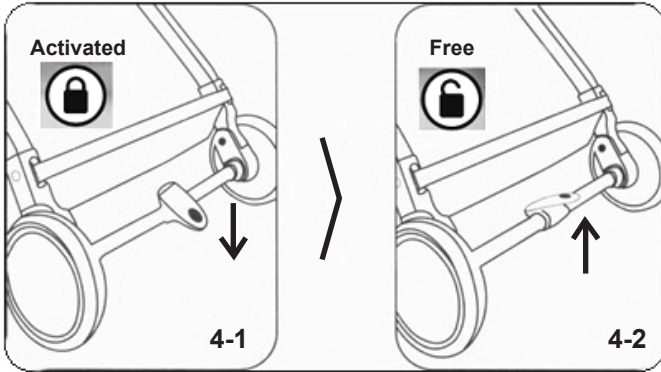

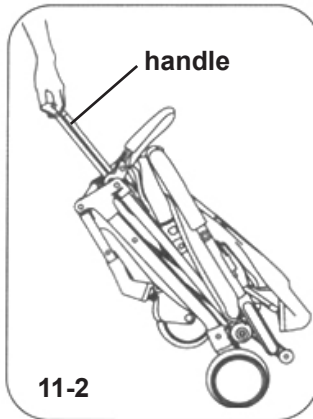
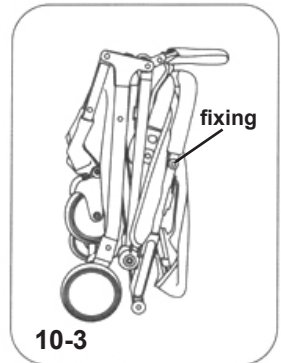
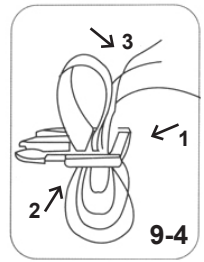
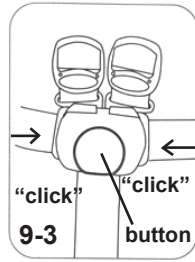
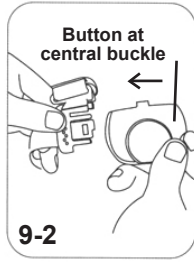
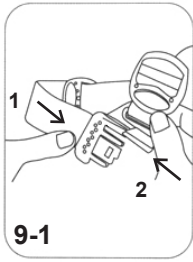

CARE AND MAINTENANCE GUIDELINES

- ❖ The brakes and wheels wear out faster than other parts. Replace them when necessary.
- ❖ Regularly oil the moving parts. Use silicone oil or silicone spray for oiling.
- ❖ Clean and oil all dirty metal and plastic parts regularly.
- ❖ Clean the fabrics, plastic parts and metal parts with damp cotton cloth or sponge and mild soap.
- ❖ Do not use aggressive detergents, solvents, bleach or spirits to clean your stroller.
- ❖ Always leave the stroller to fully dry after cleaning before you use it or store it. Mold could form if you keep your stroller moist.
- ❖ Always store your stroller indoors in clean and dry place. Do not expose to direct environment influence - sun, rain, moisture and high temperature intervals.
- ❖ Please, contact your authorized dealer for problems connected with the use or repair of this stroller.

Stroller fabric composition:

Outer: 100 % polyester

Filling: 100 % polyester



Used materials: plastic, textile, metal.

LKCT022xxxx

CHIPOLINO

Bulgaria, Plovdiv, str. Golyamokonarskoshosse 1

www.chipolino.com